

BIGBAT

6V. 1.2 Ah.

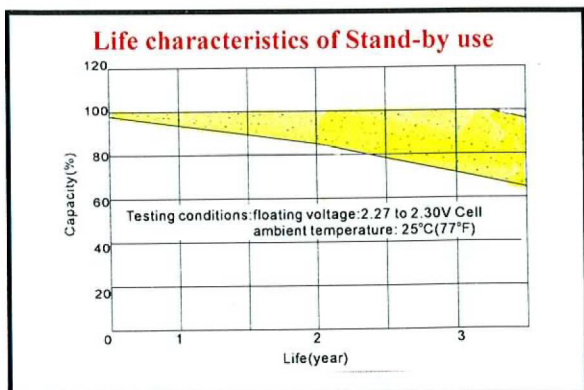
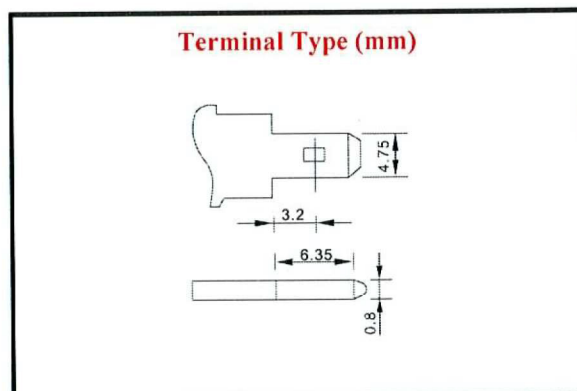
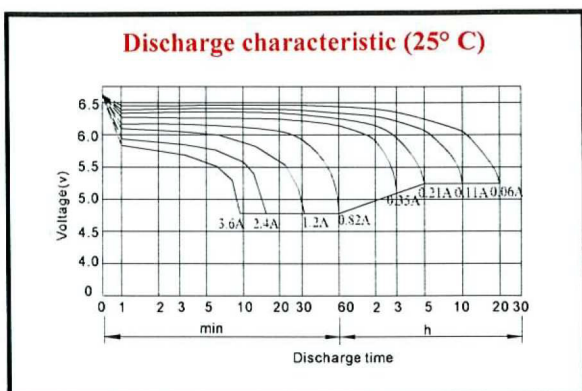
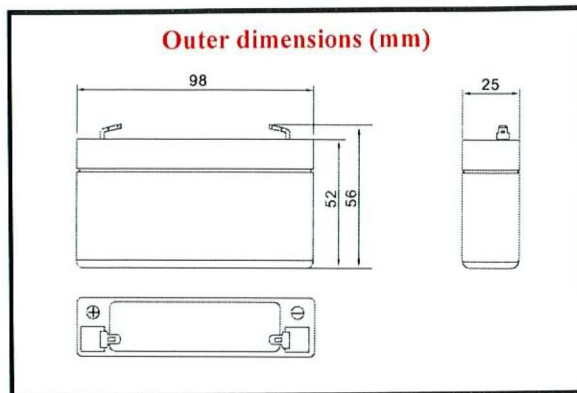

Characteristics

| | | |
|---|---|--|
| Capacity 25° C (77° F) | 20 hour rate (0.06 A) 10 hour rate (0.11 A) 5 hour rate (0.21 A) 1 hour rate (0.82 A) | 1.20 AH 1.10 AH 1.05 AH 0.82 AH |
| | 1.5 hour discharge to 5.25V | 0.50 A |
| Internal Resistance | Full charged battery at 25° C (77° F) | 37 m Ω |
| Capacity effected by temperature (20 hour rate) | 40° C (104° F) 25° C (77° F) 0° C (32° F) -15° C (5° F) | 102 % 100 % 85 % 65 % |
| Self-discharge at 25° C (77° F) | Capacity after 3 month storage Capacity after 6 month storage Capacity after 12 month storage | 91 % 82 % 64 % |
| Charge (constant voltage) | Cycle | Initial charging current less than 0.40 A Voltage 7.30 – 7.50V. |
| | Float | Voltage 6.90 – 7.00V. |

